

SPECIFICATION		
1	Model No.	YD102-07-4F55P
2	Dimension:	102*102*34H mm
3	Cone Material:	Paper
4	Edge:	Foam
5	Nominal Power:	6W
6	Maximum Power:	8W
7	Impedance:	4±15%Ω
8	Voice coil:	Φ14.28mm ASV+Cu
9	Fo:	135±20%Hz
10	Response:	Fo~13KHZ
11	S.P.L:	91±3dB (AT 0.1W/0.1M,AT 0.6.0.8.1.0.1.2 KHz)
12	Magnet Size:	Φ55*25*8mm
13	Net weight:	170g±8%

THIS DOCUMENT CONTAINS DATE
 PROPRIETARY TO PROJECTS CHANGZHOU ESUNTECH
 CO LTD. ANY USE OR REPRODUCTION,IN ANY FORM,
 WITHOUT PRIOR WRITTEN PERMISSION OF
 PROJECTS CHANGZHOU ESUNTECH CO LTD
 IS PROHIBITED.
 ©2003,Project Changzhou Esuntech Co Ltd

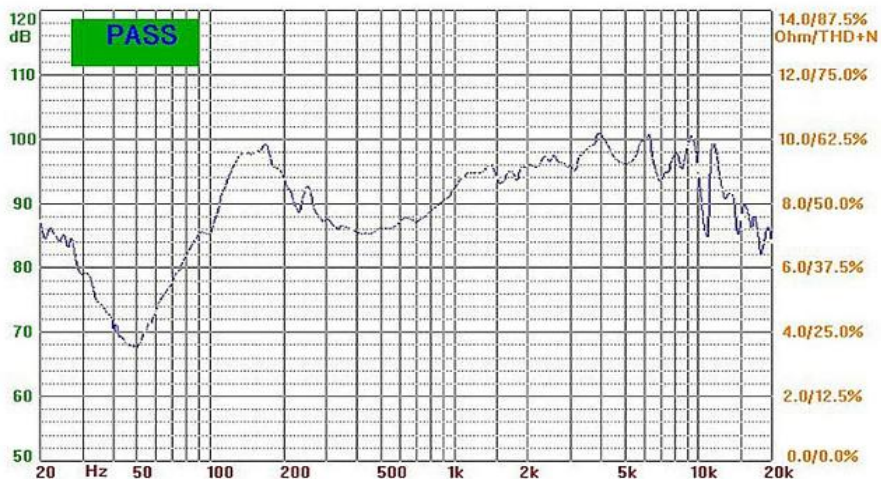

REVISION HISTORY			
LTR	DESCRIPTION	DATE	APPROVED
-	RELEASED FROM ENGINEERING	9/23/2003	Y M
A			
B			
C			

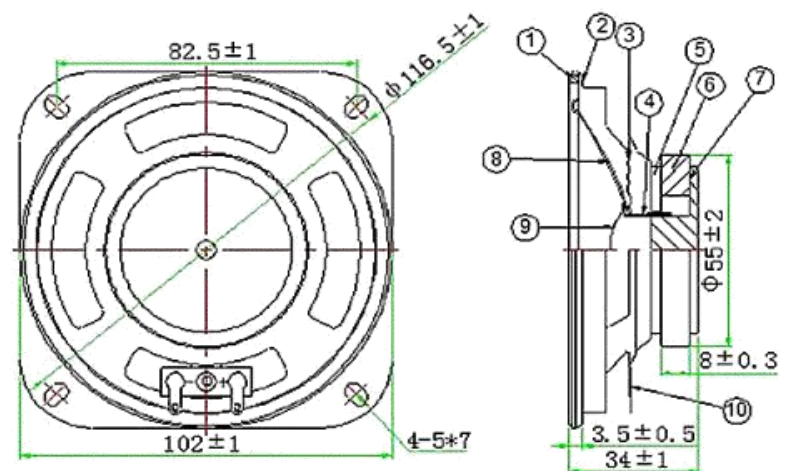

NOTES:
 1.ALL DIMENSIONS ARE IN MILLIMETERS
 2.SPECIFICATIONS SUBJECT TO CHANGE
 WITHOUT NOTICE

UNLESS OTHERWISE SPECIFIED. DIMENSIONS ARE IN MILLIMETERS TOLERANCES ARE +/-0.5 AND ANGLES ARE +/-3°	SIZE	Designed by	Date	Checked by	Date	Approved by	Date	Drawed date	
									
	A4								
	YD45-01-8F32P-R	Changzhou Esuntech Co.,Ltd http://www.esuntech.com.cn					Loudspeaker	Edition	Sheet